



 **IWCS**
COMMUNICATION CAN SAVE LIVES



Content

Welcome to IWCS	3
iriComm 3.0 wireless	5
iriComm 3.0 wired	9
Headset attachments	10
Headset options	11
Products	12
Intelligent intercom	19
iriBelt + iri-Insert	27
iriBridge + iriBridge R	29
Research and Development	31
Specifications	33
External radios	38

Welcome to IWCS

Clear and uninterrupted communication is in many cases a mandatory requirement for getting the job done, and especially in mission critical situations being able to communicate effortlessly and with both hands free is making a world of difference.

At IWCS we are dedicated to develop advanced and user-friendly solutions providing our professional customers trouble-free communication even under the most demanding conditions whether it is for SAR, Coast Guard or Tactical operations.

To become a leading supplier on the market, IWCS benefits from an active Advisory Board with highly profiled members from High End production and International Sales, which is an asset in the strategy of the future IWCS.

We are living in times where features and product development are not our only responsibility. At IWCS we are working with United Nations Sustainable Development Goals, in order to lift our share of the burden, of making the world a better place.

Ms. Sc. E.E.
Co-Founder & CEO

” In a three-way collaboration with Garmin and IWCS, Sjöräddningssällskapet is implementing user-friendly iriSound intercom across our new generation of rescue vessels.

- Jonas Carlsson, Head of New Vessel Design



SAR boats from a volunteer rescue organization equipped with iriSound Intelligent Intercom

iriComm 3.0 - Wireless



iriComm 3.0 is a rugged waterproof headset, that comes in many versions, for both wireless or wired use, with headband or for helmet attachment and with a variety of options. The softshell earcup provides a robust and shock absorbing housing for protection against seawater, dirt, impacts etc. The softshell earcup itself requires a minimum of maintenance.

iriComm 3.0 Wireless is a multifunctional communication tool, which lets you handle several connections at the same time. iriComm 3.0 paired with another iriComm 3.0. This gives the possibility for 2 persons to be in Full Duplex Intercom without any additional equipment.

In addition to any of the above mentioned use cases, the iriComm 3.0 can be paired with a mobile phone, allowing the user to answer incoming phone calls.



iriComm 3.0 will serve you day in and day out

Specifically developed for Rescue Swimmers and for use in loud surroundings with the best performance, iriComm 3.0 has impressive specifications e.g. IPX7 waterproof rating, and Noise Cancelling Microphone that works up to an impressive 142 dB SPL., which is necessary for helicopter use.

Working in rough conditions, as helicopter rescue swimmer, in tactical teams or fire departments, the importance of clear and uninterrupted communication at sea can not be underestimated. In many cases it is what separates success from failure. Weather conditions, surrounding noise, distance to team members – all factors potentially making clear communication difficult or impossible.

Range

iriComm 3.0 is designed for short to medium range wireless connectivity, and typical range is up to 80m line-of-sight. The actual achievable range will vary depending on local factors. When used in an iriSound marine intercom system, the range can be extended significantly by using external antennas in the fixed installation.

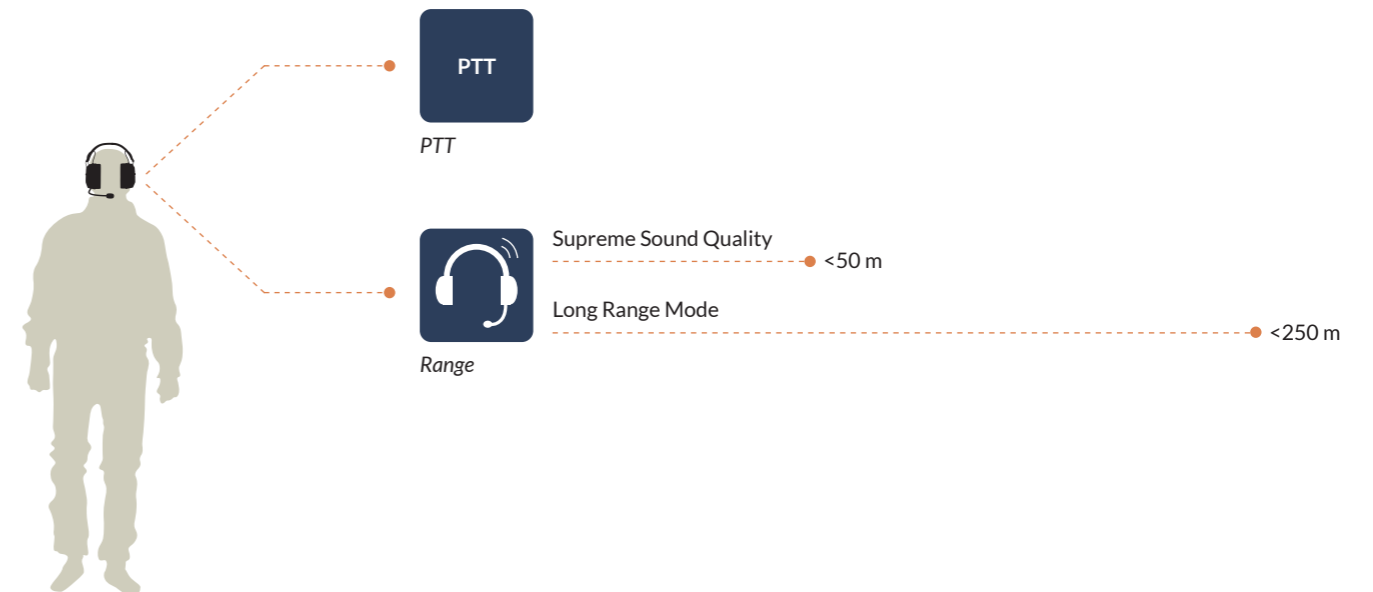

*Range depends on the surroundings





Connectivity

Used as a Stand Alone Headset iriComm 3.0 can connect to a Mobile Phone and have Music Streaming at 44.1 KHz quality. Incoming calls can be answered directly from the headset and music streaming will be set on hold immediately. When either the caller or the user hangs up the call, the music streaming reconnects immediately.

In Peer-to-Peer setup, two iriComm 3.0 Headsets can have a simultaneous mobile phone connection. The two users will have Full Duplex Intercom. An incoming phone call can be accepted directly from the headset, and will, when accepted, disconnect the intercom for the duration of the phone conversation. When a mobile phone call is hung up the Intercom mode is reactivated instantly.

In an iriSound Intercom set up with more than two users and maybe external radio connections, the iriComm 3.0 headset will provide Full Duplex Intercom to all users. External radios will be integrated in the solution and allow everybody to hear everything... Using an iriSelect - up to 9 talk group setups can be defined.

Peer-to-Peer functionality

P2P enables two iriComm 3.0 headsets to be wirelessly connected forming a stand-alone, full-duplex intercom system.

Voice Prompts

iriComm 3.0 Wireless has Voice Prompts, which give the user audible information when any change is made. Connections or lost connections, battery status, ON / OFF information, charge mode, pairing etc.

Wireless PTT

Pairing is also used when connecting the headset to a hand-held radio with wireless PTT support. iriComm 3.0 supports wireless PTT function according to IWCS and Peltor standard. When iriComm 3.0 is part of an iriSound intercom system the wireless PTT function will be able to key external radios being part of the iriSound intercom system.

SPL Microphone

The noise-cancelling boom microphone on iriComm 3.0 is capable of handling extreme background noise levels without compromising voice intelligibility. It can handle an impressive soundpressure level (SPL) of 142dB.

3D GEL Ear-pads

To increase the passive noise attenuation of the headset as well as improve the physical fit, IWCS has developed a 3D GEL Ear-pad. The design of the Ear-pad ensures a closer fit against the cranium around the ear. This option provides up to an extra 5dB of passive noise attenuation.

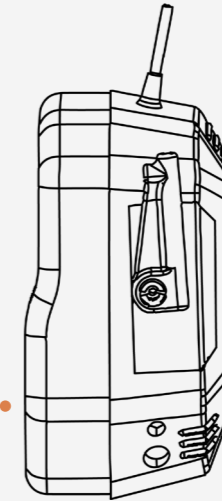

Charging

iriComm 3.0 wireless (and some wired PLUS versions) has an advanced battery and charge circuit. The 800 mAh LiPo/LiIon battery provides long life and long operational time.

Options:

- Helmet (see page 10)
- PLUS Package (see page 11)

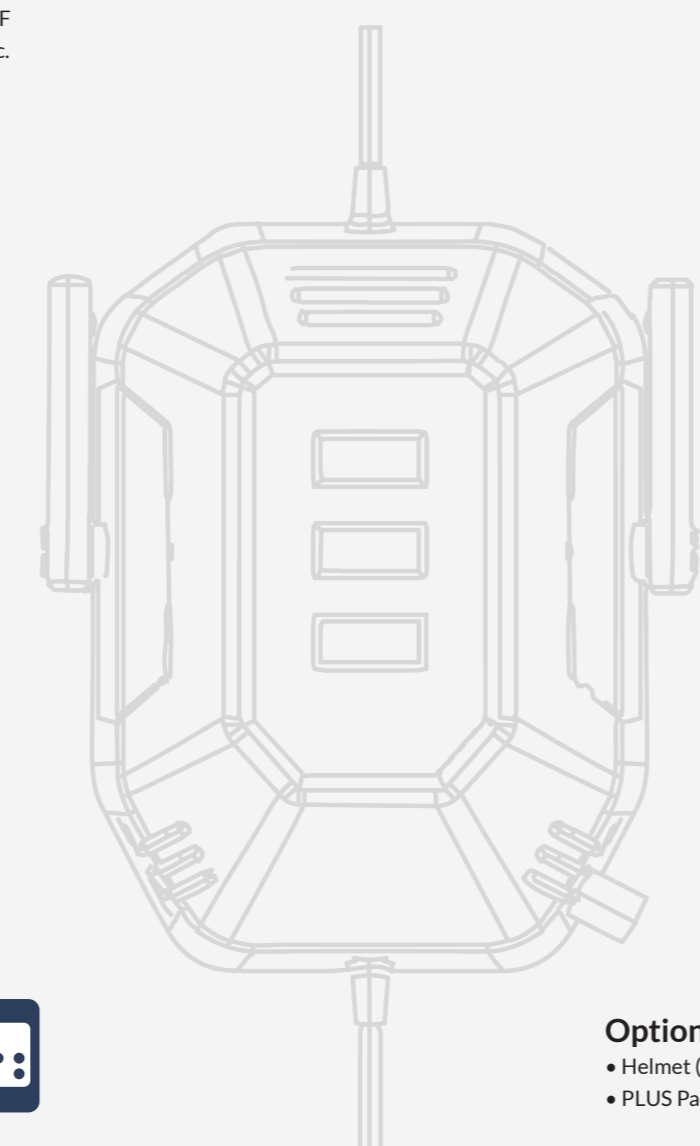
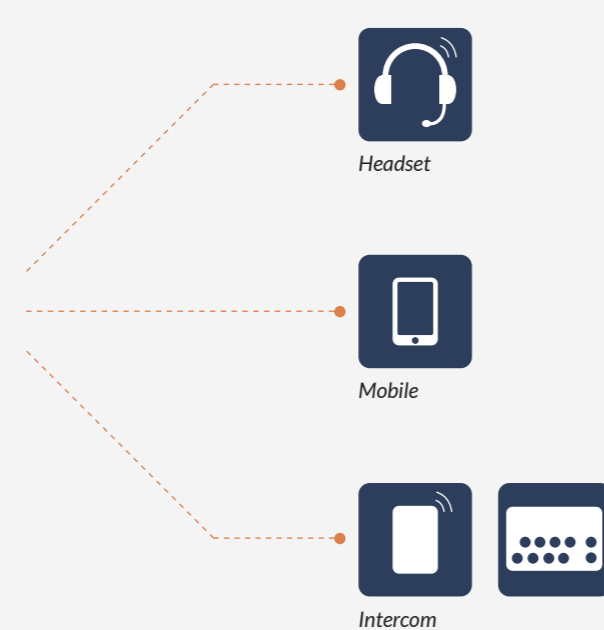

“ We understand that the electronics are pushed as hard as the users and know that quality equals safety.

- Stig Nielsen - CEO Tronex (EMS)

iriComm 3.0 - Wired



With its unique and patented design iriComm 3.0 is engineered to provide best in class audio quality under extreme conditions. The use of high-grade silicone and stainless steel in combination with a completely sealed construction make iriComm 3.0 the ideal choice for those working in noisy, wet and salty environments.

Our iriComm 3.0 headset is supplied with a radio-specific connector matching your handheld radio. Depending on radio model, attaching the headset may disable the radio's internal microphone and speaker.

Volume control is handled by operating the radio's volume setting.

PTT function on the headset is available to activate the radio for outgoing calls.

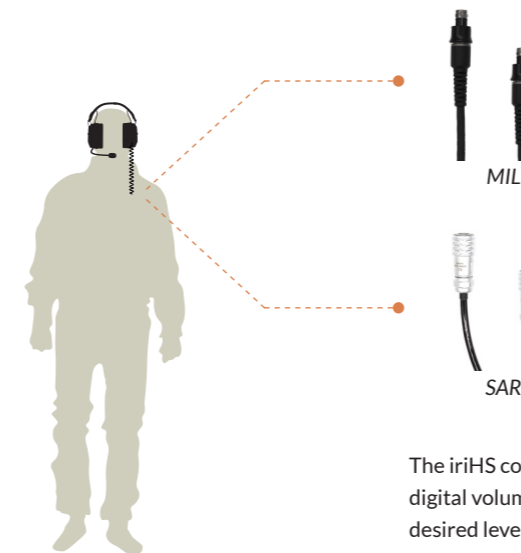

MIL



SAR

The iriHS communicates with iriSound, and the build-in amplifiers and digital volume control allow you to adjust the volume to exactly the desired level. The non-volatile memory will make sure your setting is remembered for next time the system is re-started.

With IWCS' headset connection panel you can attach your iriComm 3.0 headset directly to your onboard radio. Giving you crystal clear audio and PTT on the headset while maintaining the fist microphone as backup.

Options:

- Helmet (see page 10)
- PLUS Package (see page 11)

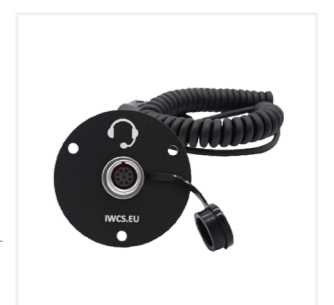



Attachment

PLUS version



Headband

When ordered in headband version, iriComm 3.0 comes with the earcups attached to a slim, lightweight headband, where the patch wire is hidden inside. The adjustable swirl arms make it easy to comfortably fit any head size.



Helmet

iriComm supports many different helmet attachments. If ordered as helmet attachments, the interconnect wire between the 2 earcups is 70 cm. Mount the wire in a secure way, behind the neck of the helmet or inside the helmet. The distance between the 2 holders is 88mm, and fits standard IWCS, Peltor bracket etc.



Combination

iriComm 3.0 can be delivered in both a headband version and a version for helmet attachment. Some users and some cases require an easy switch between the two ways of wearing the headset. The headband of iriComm 3.0 is so thin that it can comfortably be worn under a high cut helmet. Flexibility that saves you the cost of having 2 headsets.



iriComm 3.0 comes in versions with additional features - referred to as a PLUS version. All wireless and some wired versions of iriComm 3.0 can be ordered with the PLUS option. The PLUS versions have two additional features - Active Hear-Through and LED light.

LED

This feature provides three very useful light modes. Dimmed mode provides sufficient light for reading a map held in your hands without causing too much disturbance of your night vision or the people in your vicinity.

High-beam mode lights up the path in front of you, and makes it possible to move around and navigate in total darkness.

In Strobe mode the LED continuously emits powerful flashes at a constant frequency helping others locate you in the dark. Even a mile or two away a helicopter without FLIR equipment will be able to easily locate your position.

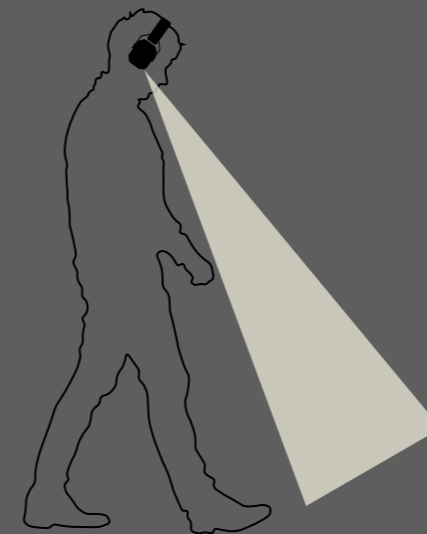

Hear-Through

Hear-Through mode makes it possible to have a "local" conversation and hear what is happening around you without removing the headset. When Hear-Through mode is enabled, sound from the intercom system or connected radio is attenuated by 24dB. This allows for monitoring intercom or radio traffic while engaging in "local" conversation.



3-Mode





iriComm 3.0 - Wireless

iriComm 3.0 is our rugged and waterproof headset, with optional Hear Through and 3-mode LED light. Specifically developed for Rescue Swimmers and for use in loud surroundings with the best performance. iriComm 3.0 has impressive specifications e.g. IP67 waterproof rating, and a Noise Cancelling Microphone that goes up to an impressive 142 dB SPL. Which is necessary for helicopter use.

- IPX7 Waterproof
- PTT
- Noise cancelling mic. (max. SPL 142 dB.)
- Headset to headset (P2P)



iriComm 3.0 - Wired

iriComm 3.0 is our rugged and waterproof headset, with optional Hear Through and 3-mode LED light. Specifically developed for Rescue Swimmers and for use in loud surroundings with the best performance. iriComm 3.0 has impressive specifications e.g. IP67 waterproof rating, and a Noise Cancelling Microphone that goes up to an impressive 142 dB SPL. Which is necessary for helicopter use.

- IPX7 Waterproof
- PTT
- Noise cancelling mic. (max. SPL 142 dB.)



iriComm 3.0 - Wireless PLUS

iriComm 3.0 is our rugged and waterproof headset, with optional Hear Through and 3-mode LED light. Specifically developed for Rescue Swimmers and for use in loud surroundings with the best performance. iriComm 3.0 has impressive specifications e.g. IP67 waterproof rating, and a Noise Cancelling Microphone that goes up to an impressive 142 dB SPL. Which is necessary for helicopter use.

- IPX7 Waterproof
- PTT
- Noise cancelling mic. (max. SPL 142 dB.)
- Headset to headset (P2P)
- 3-mode LED light
- Active hear-through



iriComm 3.0 - Wired PLUS

iriComm 3.0 is our rugged and waterproof headset, with optional Hear Through and 3-mode LED light. Specifically developed for Rescue Swimmers and for use in loud surroundings with the best performance. iriComm 3.0 has impressive specifications e.g. IP67 waterproof rating, and a Noise Cancelling Microphone that goes up to an impressive 142 dB SPL. Which is necessary for helicopter use.

- IPX7 Waterproof
- PTT
- Noise cancelling mic. (max. SPL 142 dB.)
- 3-mode LED light
- Active hear-through

iriSound 4

iriSound 4 is intended for a smaller vessel with a crew of 2-3 people, where there is probably only one external radio installed.

- Up to 4 audio/intercom ports for crew-members or external radios
- 2 AUX ports for connection of external equipment like iriSelect, iriBoost or iriStore
- 400MHz DSP core delivering impressive sound quality at 24bit/96kHz sampling
- Advanced noise cancelling/muting feature
- Preconfigured side tone suppression
- Fully waterproof design
- Built-in power supply noise filter
- Power supply 12VDC/2A



iriSound 6

iriSound 6 is intended for the medium sized vessel with a crew of up to 4 or 5 people, or where several external radios are used.

- Up to 6 audio/intercom ports for crew-members or external radios
- 2 AUX ports for connection of external equipment like iriSelect, iriBoost or iriStore
- 400MHz DSP core delivering impressive sound quality at 24bit/96kHz sampling
- Advanced noise cancelling/muting feature
- Preconfigured side tone suppression
- Fully waterproof design
- Built-in power supply noise filter
- Power supply 12VDC/2A



iriSound 8

iriSound 8 is intended for the larger vessel with a crew of 5 or more people, and/or where several external radios are used.

- Up to 8 audio/intercom ports for crew-members or external radios
- 2 AUX ports for connection of external equipment like iriSelect, iriBoost or iriStore
- 400MHz DSP core delivering impressive sound quality at 24bit/96kHz sampling
- Advanced noise cancelling/muting feature
- Preconfigured side tone suppression
- Fully waterproof design
- Built-in power supply noise filter
- Power supply 12VDC/2A



iriSelect

iriSelect is an intelligent, helm-mounted, Multifunctional radio, PTT and control unit. Which allows control of external radios, advanced audio routing and segmenting, with the iriSound any of the 9 pre-programmed audio grids can be selected at the push of a button on iriSelect.

- 4 PTTs
- Multi-color LED indication for each PTT button
- 7-segment LED display for mode status indication
- "Radio active" indication (indicates which radio has incoming transmissions)
- Switching between pre-defined operating modes (audio segmenting / talk groups)
- Adaptive Voice Activity Detection - AVAD control
- Powered from iriSound
- Error indications
- Ambient light sensor
- Stealth mode





iriConnect - Internal Antenna

iriConnect is a digital Audio/Data access point for any wireless connections. This unit is fully waterproof and can be mounted on a targa-frame or bimini top.

- 2.4 GHz Connectivity
- Powered by iriSound
- IP67 Waterproof for outside installation
- Available with REAR or BOTTOM cable connection



iriConnect - External Antenna

iriConnect external antenna is a digital Audio/Data access point for any wireless connection. The external 2.7dBi antenna provides a uniform 180 degree coverage field (must be mounted in a vertical position). This unit is fully waterproof and can be mounted on a targa-frame or bimini top.

- 2.4 GHz Connectivity
- Powered by iriSound
- IP67 Waterproof for outside installation
- Available with REAR or BOTTOM cable connection



iriConnect - External Antenna Connection

iriConnect with external antenna connection is a digital Audio/Data access point for any wireless connection. The RPTNC connector facilitates the connection to a external antenna of choice or a DAS (Distributed Antenna System) - possibly including sections of radiating cable.

- 2.4 GHz Connectivity
- Powered by iriSound
- IP67 Waterproof but outside installation is not recommended
- Available with REAR or BOTTOM cable connection



iriStore

iriStore is an audio recorder for all communication from your iriSound Intercom System. iriStore is powered directly from iriSound and default records any RX/TX from all users / radios. If an iriSelect is a part of the setup the recordings can be limited to any preset. Multiple iriStores can be connected for group recordings. iriStore uses a USB stick and handles up to 32 MB / 300 hours

iriTalk

iriTalk is an audio device capable of playing a pre-recorded message based on an input signal. The input signal can come from onboard system alarms, push-buttons, bilge sensors etc.

- MOB
- Heat
- Bilge
- Smoke
- Gas
- Engine



Headset Interface

IWCS Intelligent Headset Interface for use with iriComm 3.0 wired headset or iri-Insert.

- Volume Control
- Remote PTT for up to 4 radios
- Fully waterproof design - IP67
- Powered by iriSound



Radio Interface

IWCS External Radio Interface facilitates simple audio integration of external radios (or other audio sources) with your iriSound waterproof intercom system.

The Radio Interface is configurable to work with any commercially available radio as long as it has an external audio and PTT interface. When ordering, please specify the make and model of radio, and we will pre-configure the unit with the right settings and physical connector. We recommend using radios from one of our partners: Motorola, Sepura, Garmin, ICOM, Entel or Sailor, but the External Radio Interface is not restricted to working with these.

- Microprocessor controlled PTT function via iriSound, iriSelect and iriComm
- Direct PTT interface for simple, flush-mount PTT (IR-22-1016-01)
- Flexible/configurable radio interface
- Works with both balanced and single-ended audio interfaces
- Fully galvanic isolated
- Built-in bi-directional volume control
- Power supply via iriSound
- Multi-color status LED



iriBoost

iriBoost is an intelligent 100W CLASS D amplifier that can drive a powerful loudhailer. All iriSound models are equipped with 2 AUX ports capable of outputting superior sound quality. By connecting iriBoost to a spare AUX port, your loudhailer becomes an integrated part of your iriSound Intercom system using the headset microphones. If your iriSound Intercom system includes an iriSelect, it is possible to configure the settings so that only selected users can speak on the hailer.





iriBridge

iriBridge is intended for small vessels with a crew of max. 2 and no radio integration is required. iriBridge can also be used on larger boats where a simple, wireless person to person connection is required.

- 2 Wireless headset channels for connection of headsets
- Fully analog audio design
- Preconfigured side tone suppression
- Fully waterproof design (with sufficient protection of antenna connectors)
- Simple headset pairing with 3rd party headsets
- Power supply 5VDC/200mA (USB connector)



iriBridge R

iriBridge R is intended for small vessels with a crew of max. 2 and single radio integration. iriBridge R can also be used on larger boats where a simple, wireless person to person connection is required.

- 2 Wireless headset channels for connection of headsets
- 1 radio connection
- Fully analog audio design
- Preconfigured side tone suppression
- Fully waterproof design (with sufficient protection of antenna connectors)
- Simple headset pairing with 3rd party headsets
- Support for wireless PTT
- Power supply 5VDC/200mA (USB connector)



iriBelt MKII

When none of our fully wireless iriComm 3.0 solutions match your requirements, iriBelt is the next best thing you can get to being fully wireless. iriBelt connects to an iriInsert speaker/microphone combo, which is designed to fit in a Gecko MK11 marine safety helmet. For other helmet types, please contact us to hear about the possibilities. iriBelt MKII has two PTT buttons enabling remote activation of up to two external radios connected via an iriSound system. Improved operational range with normal/long-range capabilities.

- Fully waterproof, IP67
- Bluetooth 3.0
- Voice prompts
- Connects to the iriInsert speaker/microphone combo or to an iriComm headset
- Connects wirelessly to an iriConnect
- Connects wirelessly to most Bluetooth-enabled mobile phones
- Connects wirelessly to another iriBelt or any iriComm 3.0 unit in P2P mode
- >18 hours operation between charges



iri-Insert

- iri-Insert is a rugged helmet insert, containing an IP 68 boom mic and IP67 waterproof speakers.
- iri-Insert can easily be installed in Gecko helmets.

Headset connection panel

Moving at full throttle over ocean swells, with gale force winds and the roar of twin outboard engines, makes hearing the onboard radio impossible. With IWCS' headset connection panel you can attach your iriComm 3.0 headset or iri-Insert directly to your onboard radio of choice. Giving you crystal clear audio and PTT on the headset or fist microphone. This allows you to keep the throttle on and the mission go, for increased efficiency and speed of resolution. Obs! Connection plug may differ depending on host radio.

- IP 67 waterproof*
- Easy mounting
- Can be modified to fit any onboard radio with a rear audio/PTT interface
- Rugged IWCS design
- Aluminium salt water resistant build quality

* IP code when mated, depends on interface



Audio/Data Cable

Interface cables between iriSound and fixed interfaces.

- 1,0 m
- 2,5 m
- 5,0 m
- 7,5 m
- 10,0 m
- Customer specific length



Power Cable

12VDC power cable for iriSound.

- 1,5 m (included with iriSound)
- 5,0 m
- Customer specific length



iriSound interconnect Cable

Required when connecting two iriSound units.

- 1,0 m
- Customer specific length



” With the newest technology we did aim to supply Hamburg Police Special Forces with a State-Of-The-Art interceptor.

- Jonas Pedersen / CEO Tuco Marine Group

Intelligent intercom

The importance of clear and uninterrupted communication at sea can not be underestimated. In many cases it is what separates success from failure. Weather conditions, surrounding noise, distance to coworkers – all factors potentially making clear communication difficult or impossible.

The iriSound system combines your existing VHF/UHF radios with a State-Of-The-Art, waterproof intercom system enabling clear and trouble free communication under the most demanding conditions.

iriSound is a highly advanced audio unit that processes all sound signals to and from external units whether they are headsets, external radio units or the iriVision camera documentation system. The built-in intelligence allows for easy plug-and-play installation when used with other IWCS products – like the iriConnect for wireless headset communication.

iriSound's rugged, cast aluminum enclosure and the IP67-rated connectors offer a fully waterproof exterior construction designed specifically for the harsh conditions on board small and medium sized vessels, with freedom to install it either inside or outside.

The electronics design is based on the newest 24bit/96kHz Digital Signal Processing (DSP) technology, which offers superior sound quality and a world of software features like dynamic noise reduction, user controlled voice groups etc., some of which are offered as additional features.

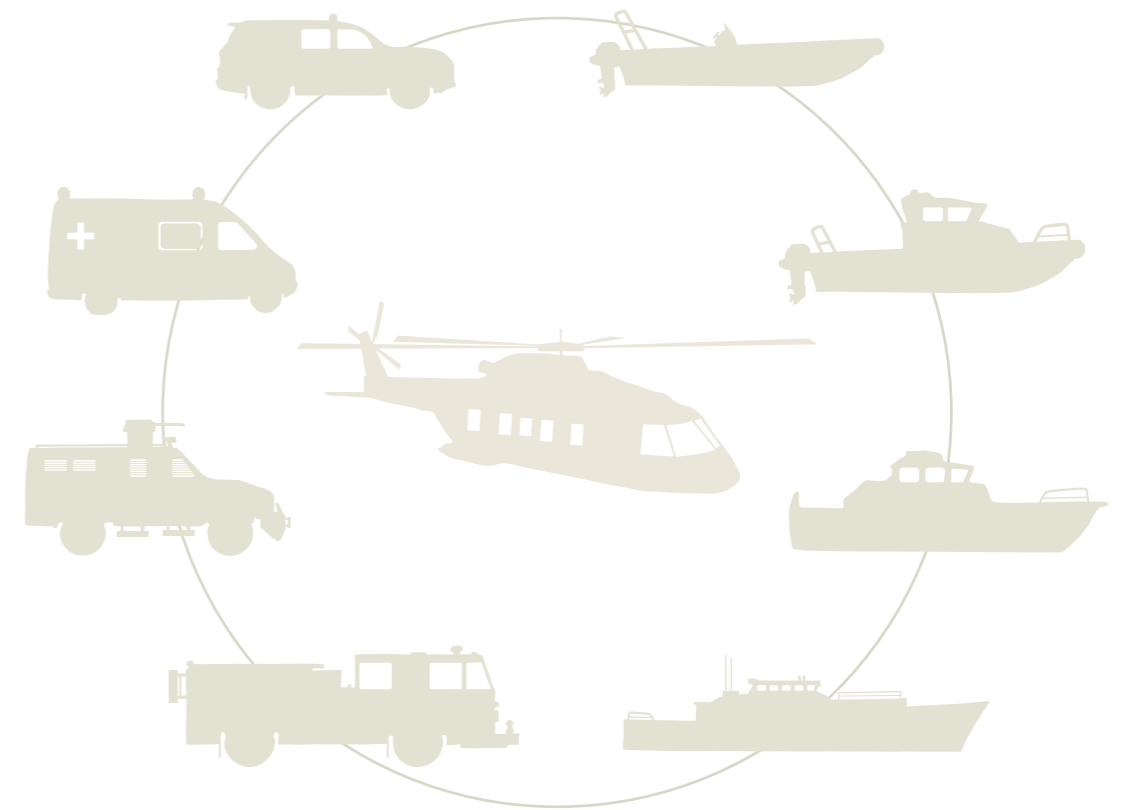

Modular

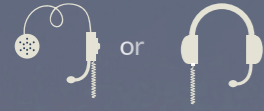

Crew members wearing either a helmet with iriInsert or a wired iriComm 3.0 headset connected into a headset connection panel and radio.

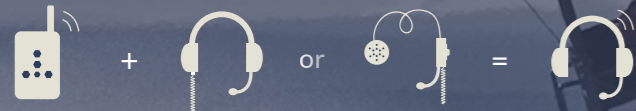

Crew members wearing an iriBelt in combination with either a helmet with iriInsert or a wired iriComm3 headset.



Wireless iriComm3 headset or iriBelt connected directly to a mobile phone while also connected to intercom.

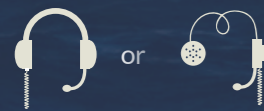

Crew members wearing either a helmet with iriInsert or a wired iriComm3 headset connected into iriHS.

The heart of the intelligent intercom is the iriSound unit itself, combining a DSP controlled mixer unit with audio from user headsets and external radios. No compromise, high quality components, advanced technology in a rugged and waterproof design, give you a professional and reliable platform. Packed with advanced features such as noise compression, automatic squelch levels and high-end military grade noise cancelling microphones, ensures you no longer miss out on vital communication. We have made the iriSound ready to go - right out of the box - so you're good to go.

The iriSound Intelligent Intercom system is modular and scalable giving you the freedom to expand your setup when needed. You can start with a few users on either wired or wireless headsets in a closed intercom system. If your needs exceed more than 10 audio channels, simply connect more iriSound units to the system. iriSound supports multiple external radios, audio recorders, external hailers, user defined grids and more.





User Interfaces

During normal use of the iriSound intercom system, the crew will not need to push any buttons - except maybe volume control and PTT when speaking on the external radios. This functionality is handled on the iriComm3 wireless headset itself, or on the iriHS for wired headsets. The additional functionality of the iriSound system is controlled via iriSelect.

iriSelect

iriSelect is the optional user interface for your iriSound intercom system. iriSelect provides access to hidden features of the system, which are otherwise not accessible to the user. See below for details.

Headset Interface

The iriHS is used when you prefer a wired connection between your headset and the intercom system. iriHS provides volume control for the attached headset as well as PTT function for up to 4 connected radios.

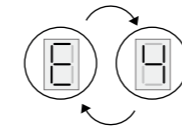

Error

iriSelect also acts as status display for the entire iriSound system, and indicates failure states like missing wireless connections. Error messages will be shown in the mode display flashing between a letter and a number. Flashing frequency is 1 sec. The ERROR indicator is normally OFF. When an error occur the ERROR indicator will flash either blue or red, and the Mode display will start flashing indicating a type and position of the ERROR.

Mode selector

Take full advantage of the iriSelect control unit, by defining extra MODE's. Default standard MODE 0 is a full open mode, where everybody can hear everybody. The iriSelect MODE switch selects one of up to 9 more (MODE 1-9) preset audio routing schemes (modes), which is instantly sent to iriSound. Each mode defines the complete port-to-port routing of all audio. For example, you can setup separate intercom nets (groups) and assign individual radios to each net, or any number of radios.

AVAD

AVAD is a very complex and intelligent squelch circuit. AVAD is adaptive and will adjust itself according to surrounding noise. AVAD is a default iriSound Integrated software, and works without using the iriSelect interface. AVAD continuously monitors the microphone signal level to maintain relevant information about the environmental noise as well as the speech level. Constantly, the squelch level will be adjusted to a level where only peaks (voice) will open the microphone. AVAD ensures complete silence in between speech.

Dimmer

iriSelect has a built-in light sensor, that automatically adjust the LED light to a comfortable level. The light will be adjusted at iriSelect, headset interface and radio interfaces.

Stealth/NVG

The standard iriSelect adapts to surrounding light levels by dimming all indicator LEDs accordingly. For users of Night Vision Goggles (NVG) this is typically not sufficient, and the NVG-compatible version is required.

PTTs with RX/TX indication

The PTT will activate TX on the selected radio. TX indicator lights up when the selected radio Transmit. If more than one PTT is connected to the radio interface, the indicator will light up no matter which PTT is activated. RX indicator lights up when the selected radio receives incoming voice.

RX/TX control of up to 4 radios

iriSelect has 4 radio PTTs, each with both RX and TX indication. Both RX and TX indications are normally OFF. Each PTT will only be functional, if the corresponding Radio Interface and external radio is connected.

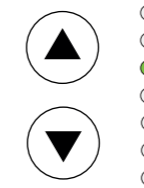
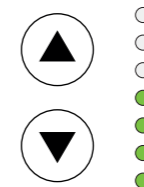
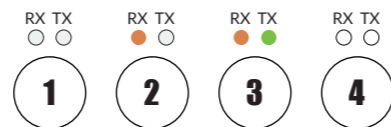

Volume control mode

In volume control mode, the two buttons function as "Volume UP" and "Volume DOWN". Actual volume is indicated by a row of LEDs.

PTT mode

The iriHS can be switched into PTT mode, where the user can select one of up to 4 connected radios. PTT function can be activated both on iriHS itself and on the connected headset.



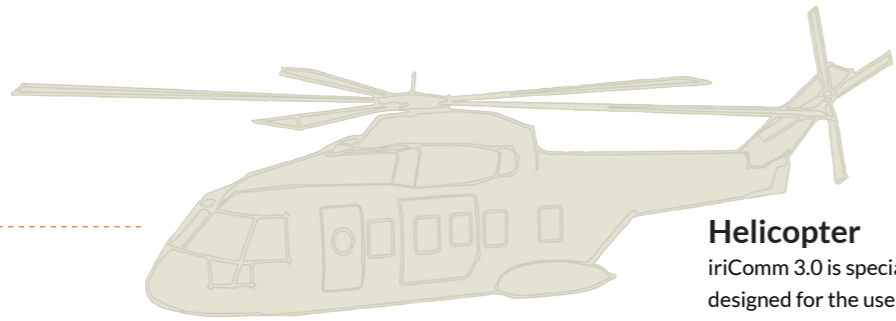

Helicopter

iriComm 3.0 is specially developed and designed for the use by a helicopter rescue swimmer, taking into consideration waterproof for seawater and RX /TX in extreme loud surroundings. During development a couple of other useful features have been added, and today iriComm 3.0 is a unique multi functional tool which combines high quality sound with user friendly controls among many other features.



Ambulance

During an emergency drive there is a lot of noise from both sirens, wind and the engine ... all at the same as that important information must be given and received, via radios and internally in the driver's cabin and patient cabin.

iriSound Intercom ensures that all communication takes place in a secure manner and that no vital information is lost or misunderstood.

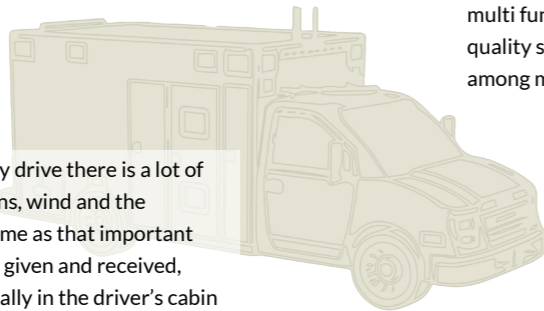

Armored vehicles

Armored vehicles are often very noisy while driving and communicating with the outside world can be vastly improved by installing an iriSound intercom system.

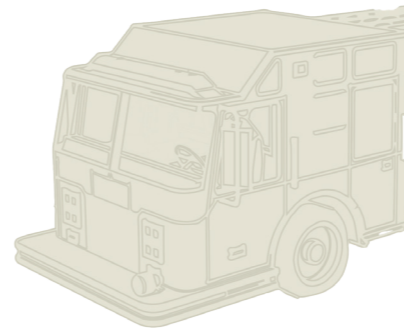
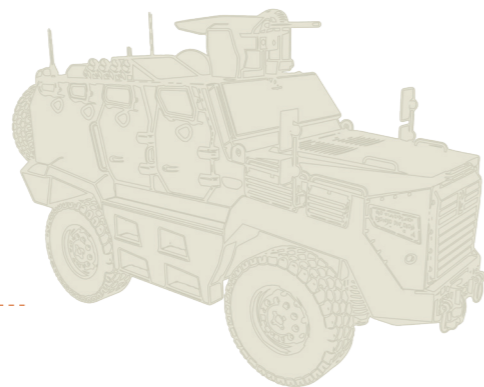

Fire truck

Working with chemicals or smoke, requires a respiration mask. The respiration mask is an audio obstacle and reduces the audio quality significantly.

Most common scenario is that 2 users are working in a pair while being able to communicate in Full Duplex, and also being able to listen to the external radio. When the radio needs to be answered, a large easy-access PTT is needed

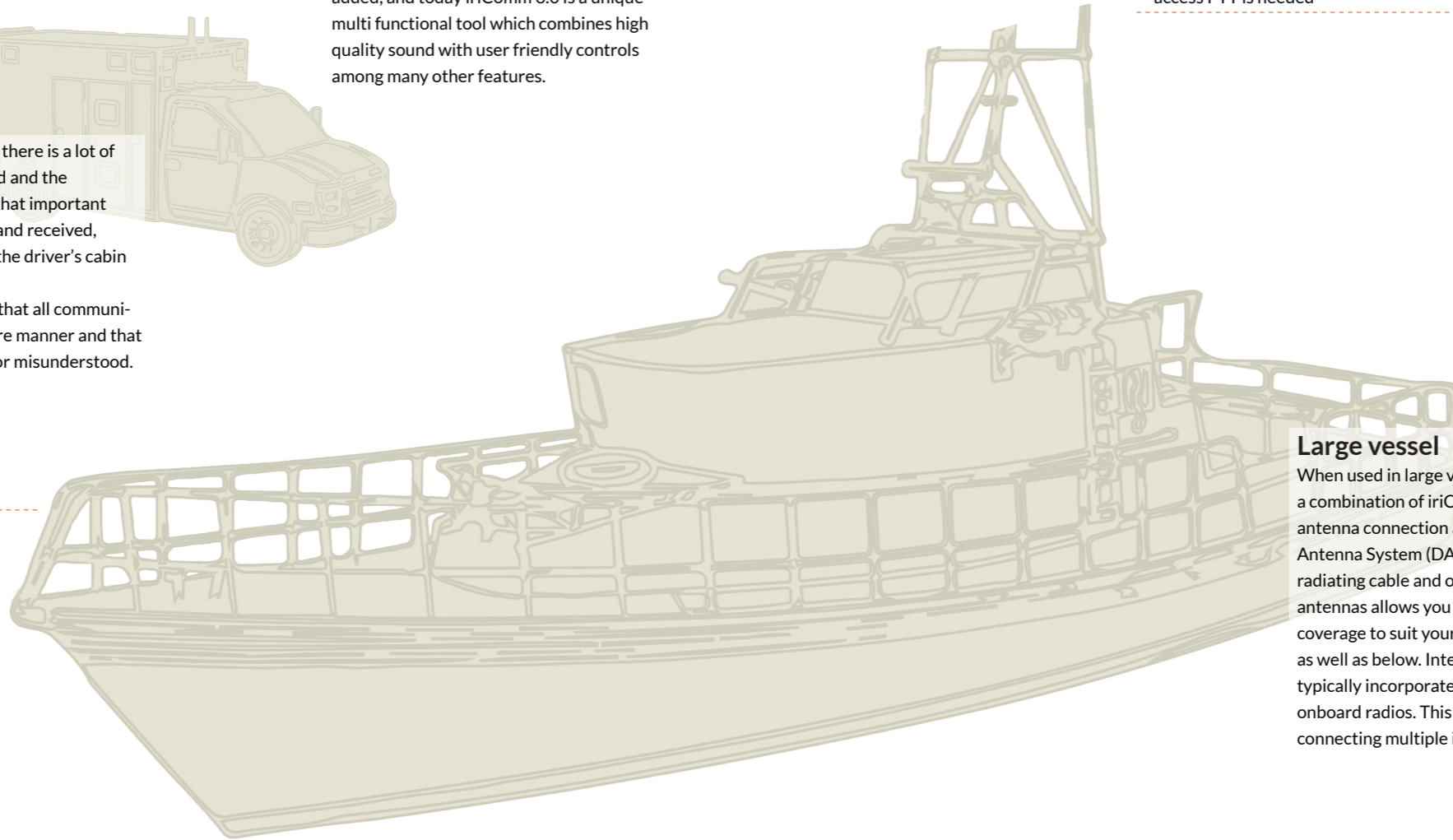
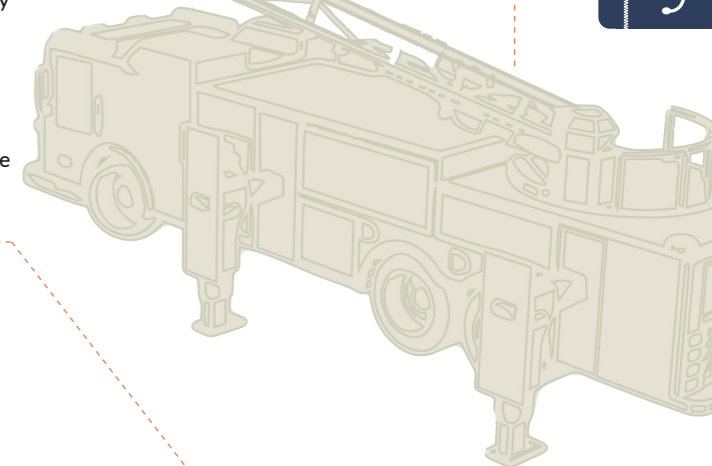

Large vessel

When used in large vessels (typically >20m) a combination of iriConnect with external antenna connection and a Distributed Antenna System (DAS) consisting of lengths of radiating cable and omni-directional- or panel antennas allows you to tailor the wireless coverage to suit your purpose - above deck as well as below. Intercom in larger vessels typically incorporate a larger crew and more onboard radios. This can be achieved by inter-connecting multiple iriSound units.



Small vessel

For use in smaller and often fully open vessels, all the iriSound intercom components are designed to withstand the marine environment. A range of iriConnect wireless connection points is available to meet a variety of wireless coverage scenarios.

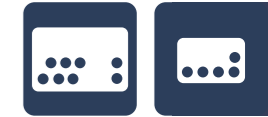
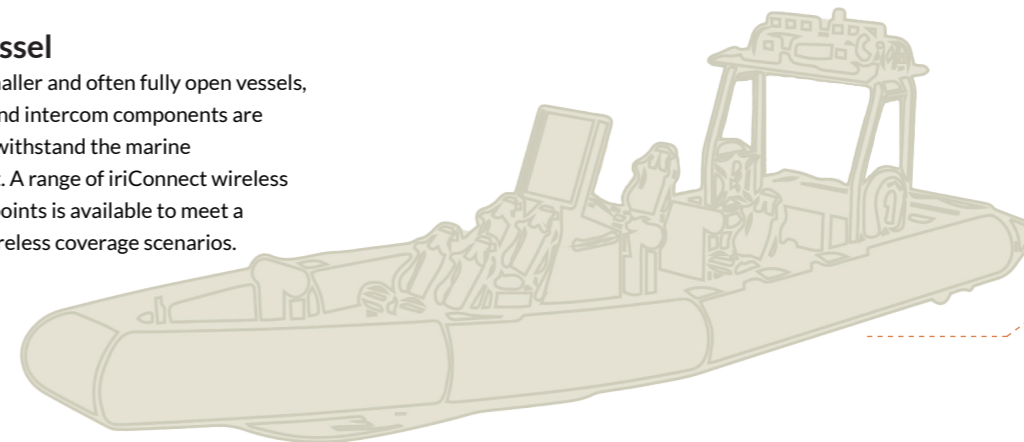



“ Having years of experience with IWCS intercom in our boats and small vehicles it was obvious to implement intercom in our large trucks.

- Fire Chief / Claus Larsen - NSBV

iriBelt MKII

iriBelt is a pocket-sized wireless transceiver predominantly used in connection with iriInsert for wireless intercom using closed marine safety helmets (e.g. Gecko). iriBelt can also be used with 3rd party headsets or, in special cases, a waterproof in-ear headset.

iriBelt supports one primary and one secondary wireless connection. When used in a full-duplex intercom setup, the primary connection is used for the intercom. The secondary can be paired with a cell phone or a handheld radio, or it can simply be left unpaired.

iriBelt has an advanced inductive battery charge circuit. The 800 mAh Li-Ion battery provides long life and long operational time - up to 24 hours.



iri-Insert

iriInsert is a high-quality audio insert originally designed for use with the Gecko MK11 marine safety helmet. Today it is also being used with other helmet models. iriInsert consists of a waterproof, high-quality, noise cancelling boom microphone and either one or two waterproof speaker units. iriInsert comes in a plethora of configurations to suit the vast number of different hand-held radios in the market.

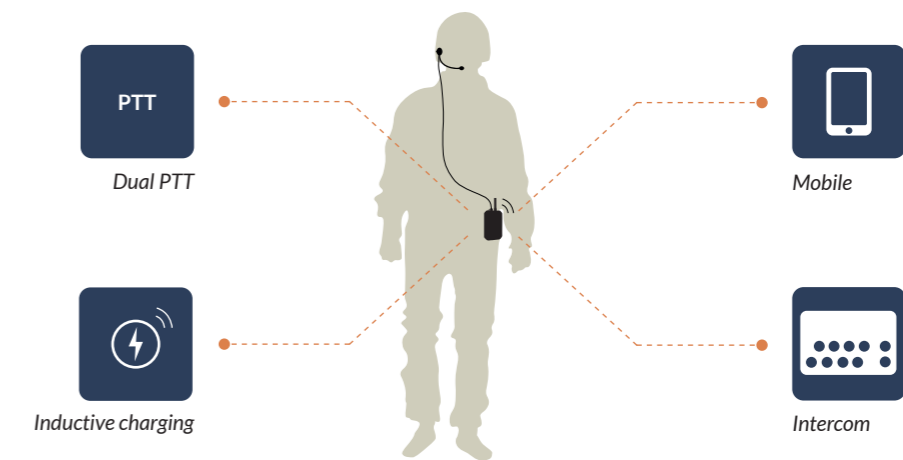



“ These P1 boats are extremely loud, but with two iri-Inserts connected via iriBelt units in Peer 2 Peer mode, we now have loud and clear communication between pilot and navigator.

- David Finlayson, P1 race pilot



iriBridge

iriBridge allows two headsets (iriComm or 3rd party) to be connected in full-duplex mode over a significant distance providing wireless intercom between two people. Typical use is onboard larger pleasure crafts, industrial settings, construction sites etc.

iriBridge R

iriBridge-R provides the same basic functionality as the iriBridge but with the addition to connect an external radio, which both headset wearers can hear. The unit also supports wireless PTT when used with iriComm3 headsets or other compatible headset.



iriBridge R only



3rd Party

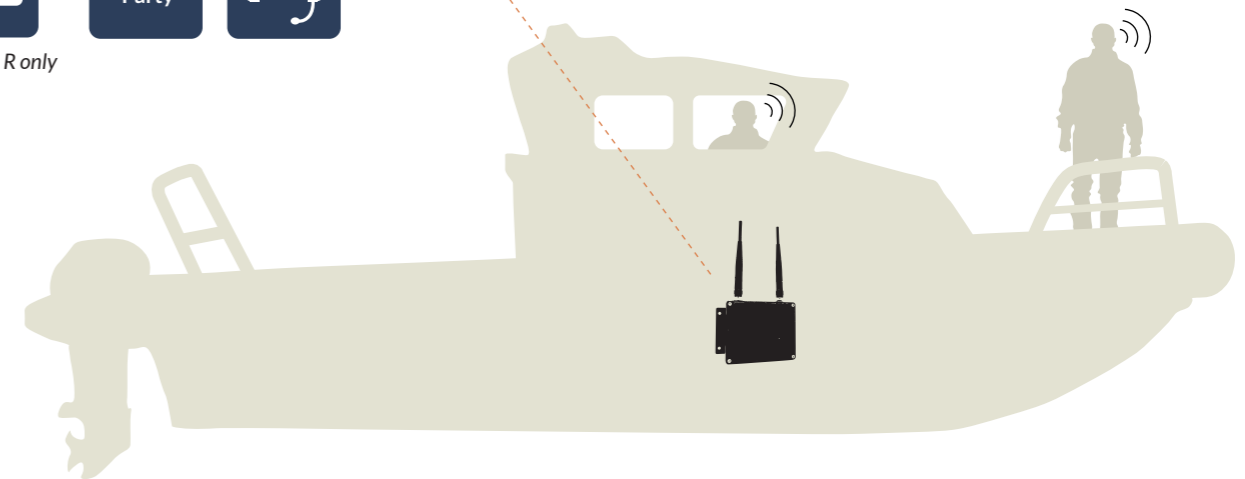



” For many years I drove without any means of communications during races. Now I cannot live without it - it changes everything.

- Rasmus Koch Hansen / European champion and 3rd in the world championship parallel slalom, Team Lindbergh Racing

Oliver Koch Hansen - Team Lindbergh Racing

Research and Development



IWCS Unique Solutions

Over the years, by servicing customers like Search & Rescue teams, Firefighters, Navy/Marine and helicopter rescue services world wide, we have become well aware of the special nature of these people's daily challenges. We have listened to them and designed our products to meet their specific needs.

IWCS have electronics and mechanical designers, and our solutions are designed and engineered all the way from initial drawings to selecting the boxes products are shipped in. Our well equipped facilities include CNC controlled machinery and 3D printing for prototyping and production of small volume, customer specific units.

Besides our standard products in the iriSound and iriComm families, we also provide customer specific solutions and turnkey projects. We have in-house test facilities allowing us to simulate depths down to 50m, and can offer product development to meet very unique offshore and sub-surface requirements – e.g. customized diver-to-diver and diver-to-surface communication systems.

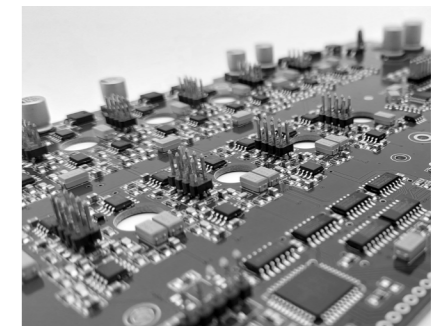

Case story

Team Lindbergh Racing is in the absolute world elite in both JetSki and RunAbout and when competing with professional teams from the Middle East and the USA, the details become crucial.

In collaboration with Team Lindbergh Racing, IWCS has designed and developed communication that fits the racing helmets, so that the driver and mechanic can communicate during training and races. Developers from IWCS were trained to handle these racing machines to understand the challenges and demands of this development. The high noise conditions combined with salt water require a great understanding of the element, which can not only be achieved theoretically - IWCS was in it all the way.



”IWCS made it possible for me to speak with the team during the races - it has a big impact in the races how we are able to communicate and understand each other - we are able to change strategy during a race and turn things into a win.

For many years I drove without any means of communications during races. Now I cannot live without it - it changes everything”

- Rasmus Koch Hansen / European champion and 3rd in the world championship parallel slalom, Team Lindbergh Racing





“The communication between the paramedic, the patient, the relative and the driver can be enhanced significantly with iriSound Intelligent Intercom.

- Lars Haagh / CEO and chief engineer at IWCS

Specifications

DSP Mixer	irisound 4	iriSound 6	iriSound 8
Audio/data channels	4	6	8
AUX ports	2		
Weight	500 g		
Size	230/250 x 145 x 50/65		
Waterproof	IP67		
Power	12 VDC / 500mAh	12 VDC / 600mAh	12 VDC / 800mAh
Temperature range	-20 C to +65 degrees Celsius		
Frequency range	20 - 48.000 Hz		
Part number	IR-14-0200-01	IR-16-0200-01	IR-18-0200-01

iriComm 3.0 wired	Headband	Helmet	Headband - PLUS	Helmet - PLUS
Radio	Bluetooth 3.0			
Weight	380 g + cable	320 g + cable	380 g + cable	320 g + cable
Waterproof	IPX7			
No. of PTTs	1			
3-Mode LED	-	-	Yes	Yes
Hear Through	-	-	Yes	Yes
Battery	Non, from radio or built-in battery (depends on variant)			
Charge time	< 3 hours			
Standard earpads	Included			
3D gel earpads	Option			
SNR	> 26dB			
Frequency range	20 - 20.000 Hz			
Storage temperature	-25 C to + 55 degrees Celsius			
Boom flexibility	>1000 x 180° bends (max 70 mm bend radius)			
MIL-std-810g— Designed to meet	503.6 Temperature Shock, 505.6 Solar Radiation, 509.6 Salt Fog, 512.5 Immersion, 515.7 Aacoustic Noice, 521.4 Icing/Freezing Rain			
Part number	IR-34-1111-0X-YYYY	IR-34-1211-0X-YYYY	IR-34-1112-0X-YYYYY	IR-34-1212-0X-YYYYY

iriComm 3.0 wireless	Headband	Helmet	Headband - PLUS	Helmet - PLUS
Radio	Bluetooth 3.0			
Weight	480 g	420 g	480 g	420 g
Waterproof	IPX7			
Long range	Up to 150 meters (standard sound quality)			
Standard range	Up to 50 meters (high sound quality)			
No. of PTTs	1			
3-Mode LED	-	-	Yes	Yes
Hear Through	-	-	Yes	Yes
Battery	800 mAh(up to 24h use between charges)			
Charge time	< 3 hours			
Standard earpads	Included			
3D gel earpads	Option			
SNR	> 26dB			
Frequency range	20 - 20.000 Hz			
Storage temperature	-25 C to + 55 degrees Celsius			
Bluetooth class	Class I			
Boom flexibility	>1000 x 180° bends (max 70 mm bend radius)			
MIL-std-810g— Designed to meet	503.6 Temperature Shock, 505.6 Solar Radiation, 509.6 Salt Fog, 512.5 Immersion, 515.7 Acoustic Noise, 521.4 Icing/Freezing Rain			
Part number	IR-34-2111-0X-XXXXX	IR-34-2112-0X-XXXXX	IR-34-2211-0X-XXXXX	IR-34-2212-0X-XXXXX

iriConnect	Internal Antenna	External Antenna	External Antenna Connection
Weight	220 g		
Size	75 x 50 x 110 mm		
Waterproof	IP67		
Temperature range	-20 to +65 degrees Celsius		
Connectivity	IWCS Bus		
Audio resolution	16 bits		
Frequency range	20 - 20.000Hz		
Power Supply	Powered by iriSound		
Part number	IR-20-1050X-03	IR-20-1051X-01	IR-20-1053X-01

iriSelect	
Weight	350 g
Size	110 x 75 x 50 mm
Waterproof	IP68
Temperature range	-20 to +70 degrees Celsius
Connectivity	IWCS Bus
No. of PTTs	4
Audio modes	Up to 10
NVG compatible	NVIS Class B (optional)
Power Supply	5 VDC (from iriSound)
Part number	IR-20-1040-01

iriBoost	
Weight	350 g
Size	110 x 75 x 50 mm
Waterproof	IP68
Temperature range	-20 to +40 degrees Celsius
Audio resolution	20 - 20.000Hz
Interfaces	1 x PWR (12 VDC) + iriSound + speaker
Power Supply	10-24 VDC / 10A (max)
Output power	Class D - 100W max
Part number	IR-20-1220-01

Radio Interface	
Weight	230 g
Size	75 x 110 x 50 mm
Waterproof	IP67
Temperature range	-20 to +70 degrees Celsius
Connectivity	IWCS Bus
Frequency range	20 - 20.000Hz
Power Supply	Powered by iriSound
Part number	IR-20-1071-03-XXXXX

iriTalk	
Weight	230 g
Size	75 x 110 x 50 mm
Waterproof	IP67
Temperature range	-20 to +70 degrees Celsius
Power	IWCS Bus
Language	Predefined english
Part number	IR-20-1110-01

iriBelt	
Weight	210 g
Size	80 x 28 x 127 (207 with antenna) mm
Waterproof	IP67 (headset mated)
Temperature range	-15 to +55 degrees Celsius
Standard range	Up to 50 meters (high sound quality)
Long range	Up to 250 meters (standard sound quality)
No. of PTTs	2
Battery	800 mAh Li-Ion
Charging	Qi inductive
Inductive charge time	3 hours
Frequency range	20 - 20.000 Hz
Part number	IR-20-2011BBK-01-IR006

iri-Insert	Single	Dual
Weight	82 g	106 g
Diameter	50 mm	
Waterproof	IP67	
Temperature range	-20 to +65 degrees Celsius	
PTT	Optional	
Microphone	Left or right	
Audio	Speaker: 200 - 8.000Hz Military grade, noise cancelling boom microphone. Voltage supplied from radio	
Termination	Spiral cable with connector for iriBelt or radio specific connector for direct radio connection	
Part number	IR-33-00XXX-02-XXXXX	

	iriBridge	iriBridge R
Weight	452 g	
Size	120/150 x 37 x 100 mm	
Temperature range	-20 to +65 degrees Celsius	
Waterproof	IP67	
Bluetooth Class	Class II	
Power	5VDC/(200mA) USB	12VDC
Antenna connector	RP-TNC	
Part number	IR-20-1060-01	IR-20-1061-01-XXXXX

Headset Connection Panel	
Weight	Depends on radio termination
Diameter	60 mm
Waterproof	IP67
Temperature range	-20 to +65 degrees Celsius
Part number	IR-40-4011-0X-XXXXX

iriStore	
Weight	250 g
Size	50 x 75 x 50 mm
Waterproof	IP67
Temperature range	-20 to +65 degrees Celsius
Frequency range	20-24.000 Hz
Sampling rate	48kb/s
Part number	IR-20-1100-01

Headset Interface	
Weight	250 g
Size	50 x 75 x 50 mm
Waterproof	IP67
Temperature range	-20 to +65 degrees Celsius
Connectivity	IWCS Bus
Audio resolution	Analog, 20 - 20.000Hz
Headset Signal	Speaker: 150mW into 8Ohms Microphone: 5mV nominal electret power
NVG compatible	NVIS Class B (optional)
Power Supply	5 VDC / 0.2A (from iriSound)
Part number	IR-20-1410-01

External radios

IWCS interface to many different handheld and mobile radios.

Below is listed a selection of radios IWCS supports. The list is dynamic and constantly being updated. If your selected radio is not present contact your local dealer or our engineers directly.

Handheld radios

Axnes
MP20, MP50
Harris
AN-PRC-152
Hytera
TC2100, YC2108, TC500, TC580, TC600, TC610, TC620, TC700, TC1600, PD502, TC2100, TC500, TC600, TC610, TC620, TC700, TC1600, PD506, PD406, PD402, PD465, PD415, PD505, PD700, PD780, PD780G, PD785, PD705, PD786, PT580, PD782, PD702, PD702G, PT580H, Digital x1e/x1p/PD602/PD600, PD605G, PD605, PD665, PD665G, PD685, PD685G, TC-320, TC-780, TC-610P, PD372, PD37X, PD36X, PD35X, TD350, TD360, TD370
Icom
IC-F3, IC-F3S, IC-F4, IC-F4S, IC-F10, IC-F20, IC-H2, IC-H6, IC-J12, IC-M5, IC-U12, IC-U16, IC-40, IC-F3G, IC-F3GS, IC-G3GT, IC-F4G, IC-F4GS, IC-F4GT, IC-F43GS, IC-F43GT, IC-F43TR, IC-F11, IC-F11S, IC-F14, IC-F14S, IC-F15, IC-F21, IC-F21S, IC-F22, IC-F24, IC-F24S, IC-F31, IC-F33, IC-F43, IC-V8, IC-V80, IC-F3G, IC-F3GS, IC-G3GT, IC-F4G, IC-F4GS, IC-F4GT, IC-F43GS, IC-F43GT, IC-F43TR, IC-F11, IC-F11S, IC-F14, IC-F14S, IC-F15, IC-F21, IC-F21S, IC-F22, IC-F24, IC-F24S, IC-F31, IC-F33, IC-F43, IC-V8, IC-V80, IC-F1000, IC-F2000., IC-F50, IC-F51, IC-F60, IC-F61, IC-F30G, IC-F30GT, IC-F30GS, IC-F31GS, IC-F31GT, IC-F31, IC-F33G, IC-F43G, IC-F43TR, IC-M87, IC-M88, IC-F3262D,F4262D Series (14pin), IC-F4262DT/DS, IC-F4400DS
Kenwood
TK208, TK220, TK240, TK248, TK250, TK260G, TK270, TK270G, TK308, TK340, TK350, TK430, TK2100, TK2207, TK3201,TK330, TK3107, TK3207, TK3160, TC265, TC270, TC365, TC366, TC380, TK3302, TK3000, NX340, TK2140, TK3140, TK3180, TK280, TK380, TK385, TK480, TK481, TK190, TK290, TK390, TK2180, TK3180, TK2212, TK5210, TK5400, Nexedge NX200, NX300, PKT-23 Protalk Radio, TPZ-D553, UBZ-M31, UBZ-M51L/S, TK-3601D, PKT-3601, NX-P500, WD-K10TR, WD-K10PBS
Maxon/Midland/Legacy
MAXON: SL25, SL55, SP100, SP120, SP130, SP140., Midland: LXT410, GXT500, GXT710., MAXON: SL100, SP200, SP200K, SP210., Legacy: PL1145, PL2245, PL2215P, PL2245P, PL2415, PL5151, PL5164., MAXON:SL25, SL55, SP100, SP120, SP130, SP140, SP410, PL1145,PL2215P,P L2245,PL2245P,PL2415,PL2445,PL5151,PL5161, PL5164,SP200
Motorola
CP88, CP040, CP100, CP140, CP150, CP160, CP200, CP1300, EP450, CT150, CT250, CT450, GP200, GP300, GP308, GP68, GP88, BC120, GTI, LTS2000, PR400, P040, P080, P110P1215, P1215LS, PRO3150, BPR40, CP1600, DP1400, DEP450, GP3688, GP3188, XIR-C2620, SP10, SP21, XTN446, XTN500, XTN600, PRO400, PRO1150, PRO2150, DTR650, DTR2350, DTR2450, XU1100, XU2600, GT1, CP100, PMR446, VL50, MTP700, GP1280, GP140, GP320, GP328, GP338, GP339, GP340, GP36, GP380, HT1250, HT1550, HT750, MTX850, MTX950, PRO5150, PRO5350, PRO5450, PRO5550, PRO5750, PRO7150, PRO7350, PRO7750, Tetra MTP810Ex, MTP850Ex, MTP700, PTX760, PTX700, PT9150, EX500, EX600, GL2000, GP328PLUS, GP338PLUS, GP344, GP388, PRO5150elite RELM: RPV30000, RPV3600, RPU3000, RPU3600, GP900, HT1000, JT1000, MT2000, MTS2000, MTX8000, MTX838, MTX900, MTX9000, MTX960, XTS2500, XTS3500, XTS5000, XTS3000, XTS500, XTS1500, EF Johnson:51SL, 5000series, 5100series, 7700series XTS1500, XTS4250, T5200, T5300, T5320, T5400, T5410, T5620, T5800, Tetra MTH650/800, i860, i710, i830, i530, i205, i730, i305, i315, i325, etc., Tetra MTH500, MTH650, MTH800, MH850, MTP850, MotoTRBO, XPR3600/6500/6550, XPR7350, XPR7550DP3400/3401/3600/3601/4000/4400/4401/4600/4601/4800, APX1000, APX2000, APX3000, APX4000, APX6000, APX7000, XIR P8620, XPR6000, XPR6300, XIR8661, XIR8628, XIR8668, MTP6550, MTP600 series APX800, MTP850S, P8620, P8268, P8600, P8608, P8660, DGP4150, DGP5050, DGP555, DGP6150, SL4000/4010, SL7550, SL1K, SL300, SL7590, DP2000/2400/2600, DP3440, DP3441, XPR3000/3300, XPR3500 MTP3250,TETRA MTP3100, MTP3200, MTP3250, MTP3100,MTP3200, XIR P6600, XIR P6608, XIR P6620, XIR P6628, MTP850FUG, MTP3550, DEP550, DEP570, MTP3000, MTP3250, for CLP Series, CLP1010, CLP1040, CLP1060, Motorola ST7500, Motorola ST7500 (with 90 degree SR)
Nexus
Nexus 4pin male, 7mm diameter works with Nexus jacks

Sepura
SRP2000, SRP3000, SRH3500, SRH3800, SRP2000, SRP3000, SRH3500, SRH3800, STP8000.STP9000, STP8X Ex
Tetra/EADS
Tetrapol G2 (MC9620), TPH700, TPH700, THR9, THR9i, THR8, TH1N, EADS: TPH900
Thales
TRC9100, PRC6809
Vertex
VX-400, VX-410, VX-420, VX-160, VX10,VX130, VX160, VX168, VX180, VX210, VX210A, VX300, VX400, VX410, VX420, VX354, VX130, VX160, VX168, VX180, VX210, VX210A, VX300, VX400, VX410, VX420, VX424, VX354, VX230, VX231, VX454, EVX351, EVX534, EVX539, VX130, VX160, VX168, VX180, VX210, VX210A, VX300, VX400, VX410, VX420, VX424, VX354, VX230, VX231, VX454, EVX351, EVX534, EVX539, MH-360M, MH-450M, VH-110, VH115M, VH-120, VH-130, VH-215M, VX600, VX800, VX900, VX530, VX-6R, VX-7R, EVX-S24, IC-4300, IC-M25, FT-207R, VX820, VX821, VX824, VX829, VX920, VX921, VX924, VX929
Yaesu
FT-60R, VX-3R, FT-250R

Mobile/fixed radios

Alinco
DR635
EADS
TMR880i
Elman
RTV-1077D
EMC
DMR-U450, DMR-V070, DMR-V160
Entel
DX4XX, HT6XX, HX4XX
Excera
EM8100
Furuno
FM4721
Garmin
200/200i, 215/215i
Icom
IC-M33, IC-M35, IC-M37, IC-M423, IC-M506-rear, IC-M60X, IC-M73, IC-M91
JRC
JHS-800S

Kenwood
NX700, TK71XX/TK81XX
Motorola
ATX, DM4000, GM3600, MTM5400, MTM800
Peitel
PTCarphone5
Raymarine
Ray63, Ray73
Sailor
62XX, RT20XX, RT40XX
Schnoor
SAR-COM
Sepura
SRG3900
Simrad
RD68, RS35, RS40
Standard Horizon
GX-1700, GX-5000
Teltronic
MDT-400

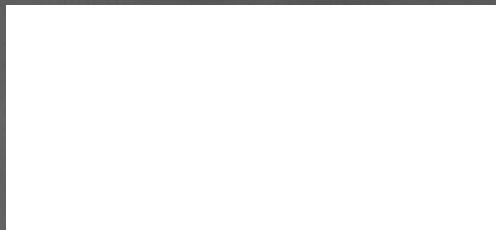

IWCS ApS • Porthusvej 7A • 3490 Kvistgaard • Denmark
www.iwcs.eu • +45 43 43 26 26 • info@iwcs.eu